

Componentes

Corrimãos e acessórios

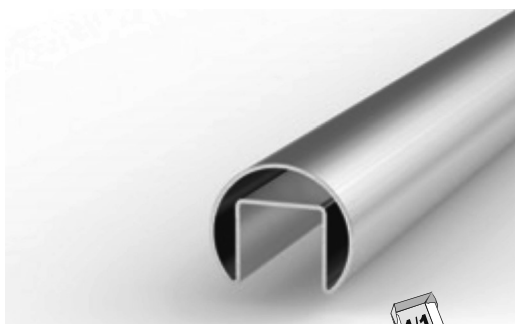

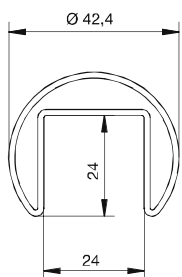

Corrimão redondo/tubo de encaixe

Artigo N.º	Material	Ø	→←	Comprimento
10242642A2	Aço inox AISI 304/Grão 240	42,4	1,5	2500
10242542A2	Aço inox AISI 304/Grão 240	42,4	1,5	5000
10242642A4	Aço inox AISI 316/Grão 240	42,4	1,5	2500
10242542A4	Aço inox AISI 316/Grão 240	42,4	1,5	5000

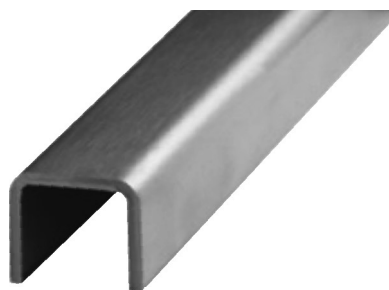
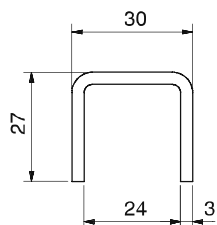
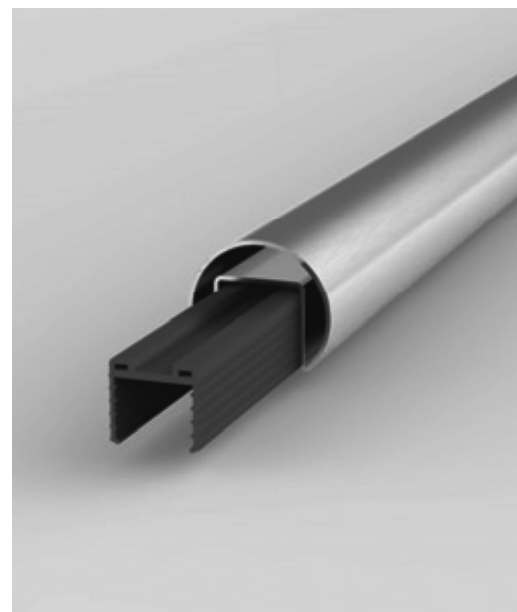

Corrimão

Artigo N.º	Material	↕	Comp.
5022VA4-5M	Aço inox AISI 316/ Grão 320	17,52/21,52	5000



Guardas em vidro sem prumos

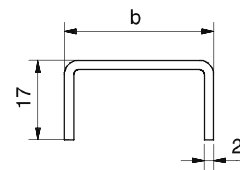
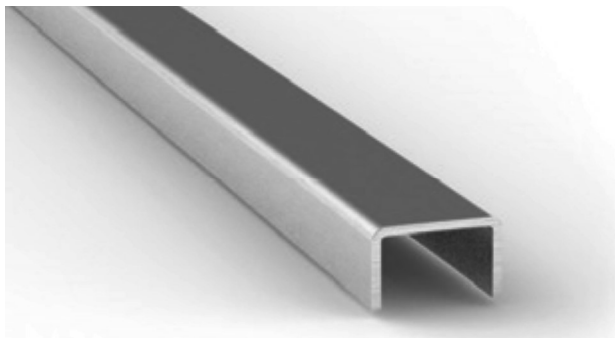

**em
preparação**

Protecção de arestas



Grão 320

Artigo N.º	Material	b		Comp.
5024VA4-5M	Aço inox AISI 316	28 mm	conforme DIN 18008	17,52
5026VA4-5M	Aço inox AISI 316	32 mm	conforme DIN 18008	21,52

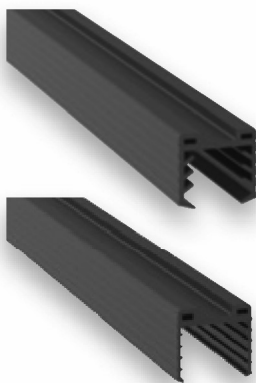
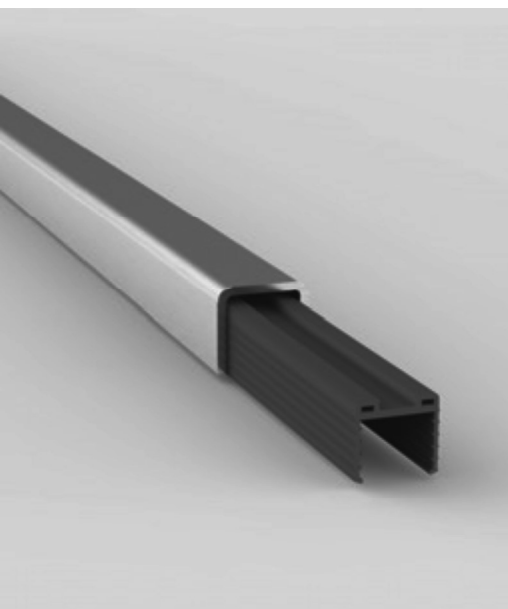

10214742KU

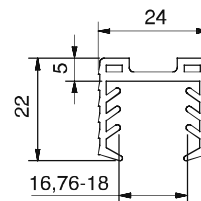

10214842KU

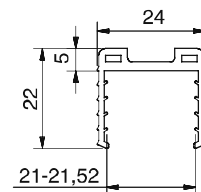

Perfil de elastómero para corrimãos

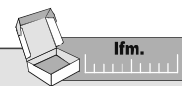

Artigo N.º	Material	Comprimento	
10214742KU	Elastómero	ml.	17,52
10214842KU	Elastómero	ml.	21,52

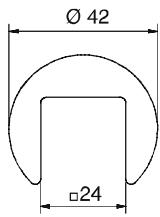

10242942BU

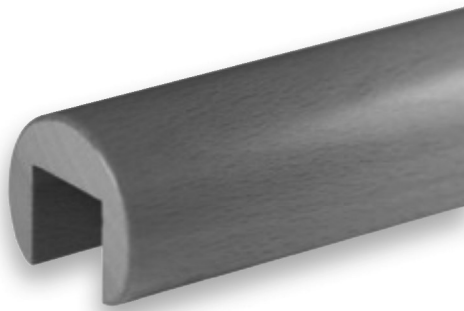

Corrimão em madeira



ranhura de 24 mm

Artigo N.º	Material	Ø	Comprimento
10242942BU	Faia vermelha suavizada	42,4	2500
10242942EI	Carvalho	42,4	2500

sem função estrutural!

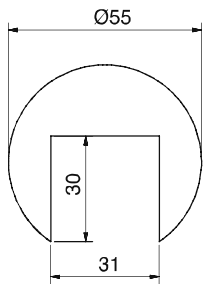
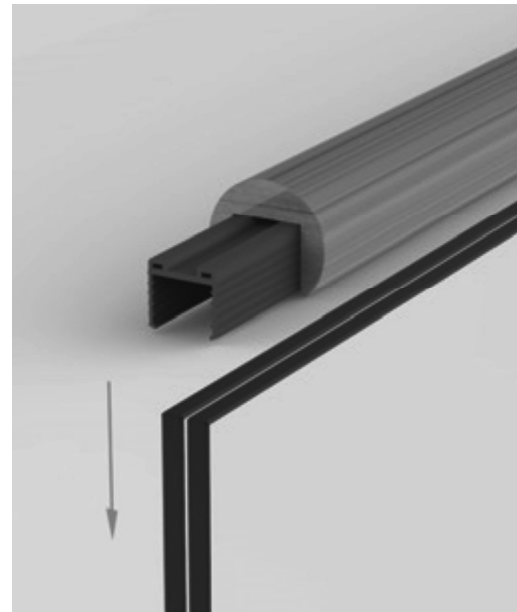

10242855EI



Corrimão em madeira



ranhura de 30 mm para perfil de protecção de arestas

Artigo N.º	Material	Ø	Comprimento
10242855BU	Faia vermelha suavizada	55	2500
10242855EI	Carvalho	55	2500

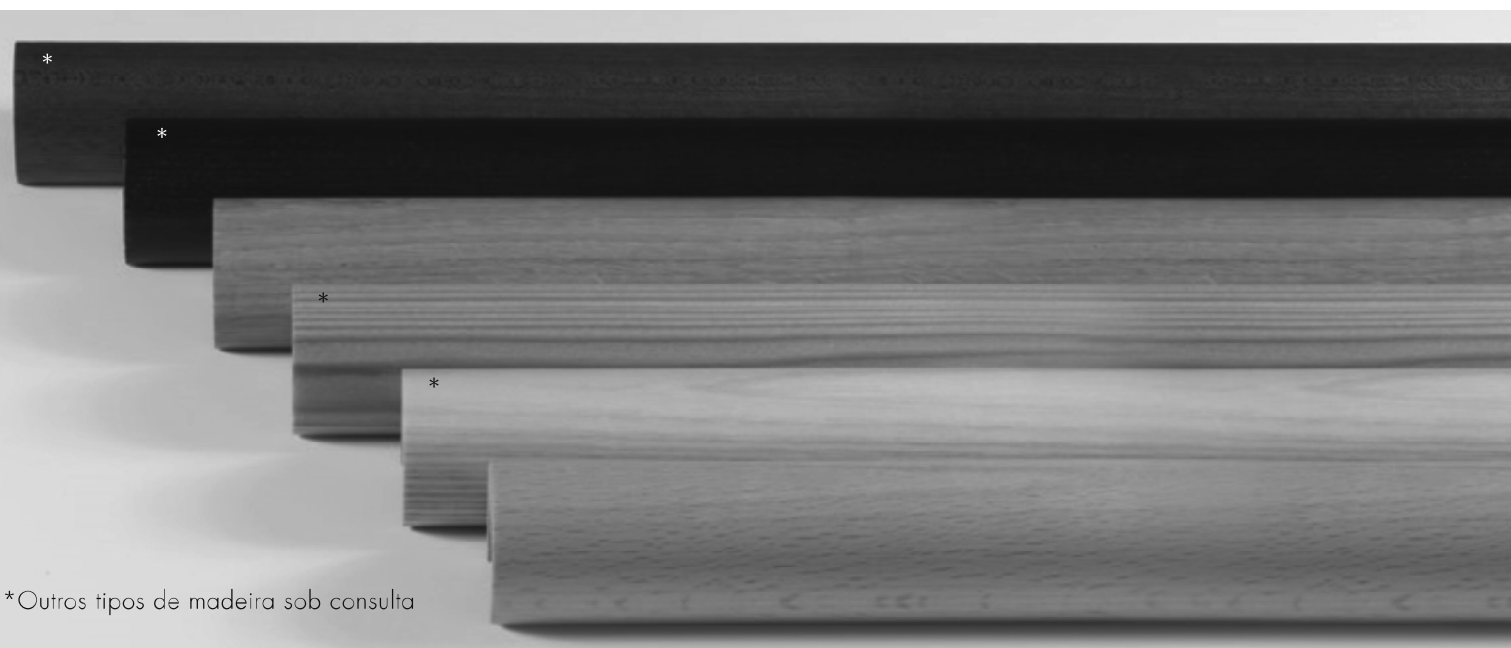

*Outros tipos de madeira sob consulta

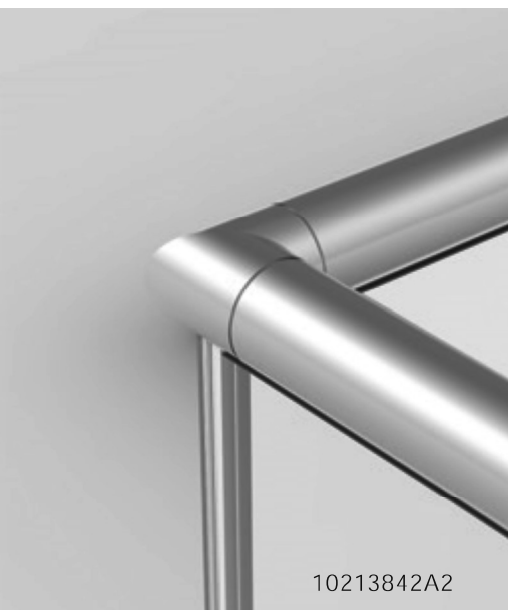

10213842A2



10213742A2



10240642A2

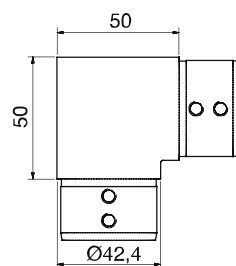
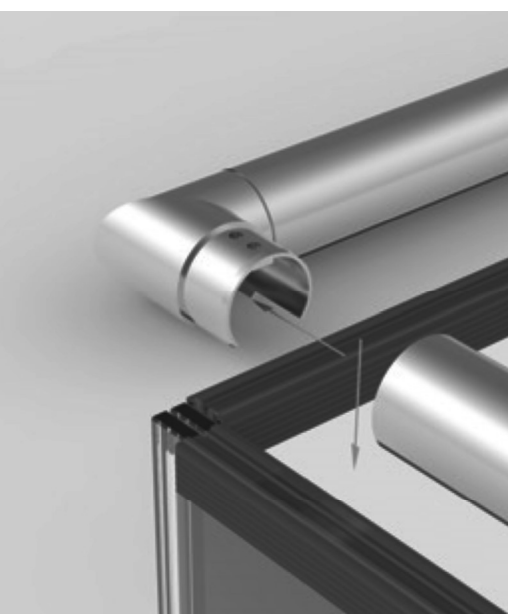

Uniões de tubos



para tubo de encaixe (90° horizontal)

Artigo N.º	Material	→✚←	para corrimão Ø
10213842A2	Aço inox AISI 304/Grão 240	1,5	42,4
10213842A4	Aço inox AISI 316/Grão 240	1,5	42,4

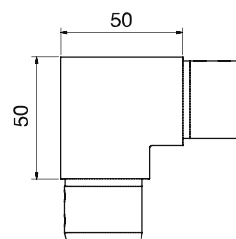
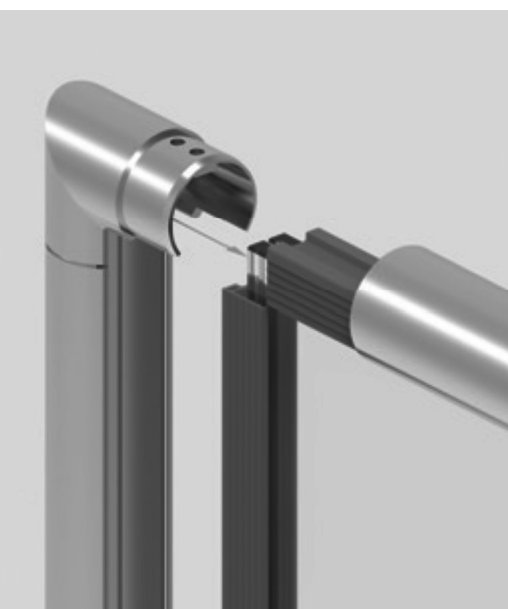

Uniões de tubos



para tubo de encaixe (90° vertical)

Artigo N.º	Material	→✚←	para corrimão Ø
10213742A2	Aço inox AISI 304/Grão 240	1,5	42,4
10213742A4	Aço inox AISI 316/Grão 240	1,5	42,4

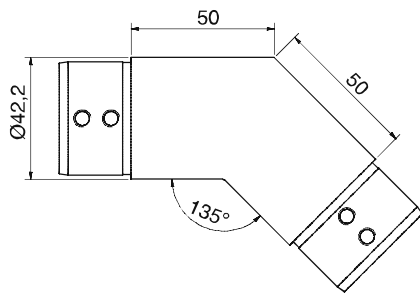

Uniões de tubos



para tubo de encaixe (135° horizontal), fixa

Artigo N.º	Material	✚	para corrimão Ø
10240642A2	Aço inox AISI 304/Grão 240	1,5	42,4
10240642A4	Aço inox AISI 316/Grão 240	1,5	42,4

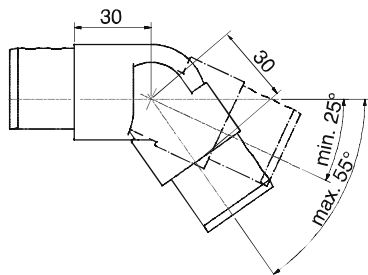

Uniões de tubos



para tubo de encaixe, articulada

Artigo N.º	Material	✚	para corrimão Ø
10240842A2	Aço inox AISI 304/Grão 240	1,5	42,4
10240842A4	Aço inox AISI 316/Grão 240	1,5	42,4

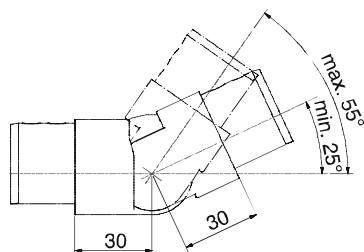

Uniões de tubos



para tubo de encaixe, articulada

Artigo N.º	Material	✚	para corrimão Ø
10240742A2	Aço inox AISI 304/Grão 240	1,5	42,4
10240742A4	Aço inox AISI 316/Grão 240	1,5	42,4





10242742A2



10233842A2

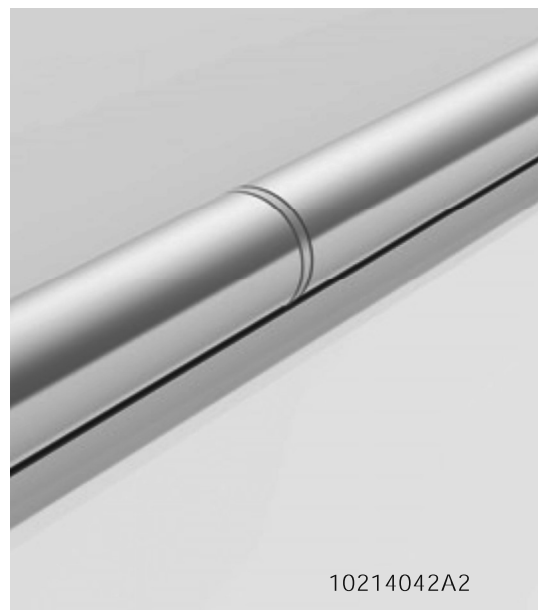

10214042A2

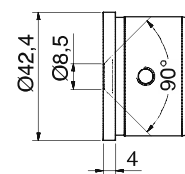

Fixação de parede



para tubo de encaixe

Artigo N.º	Material	 para corrimão Ø
10233842A2	Aço inox AISI 304/Grão 240	1,5 42,4
10233842A4	Aço inox AISI 316/Grão 240	1,5 42,4

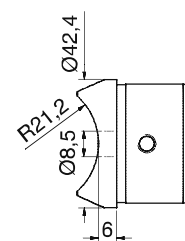
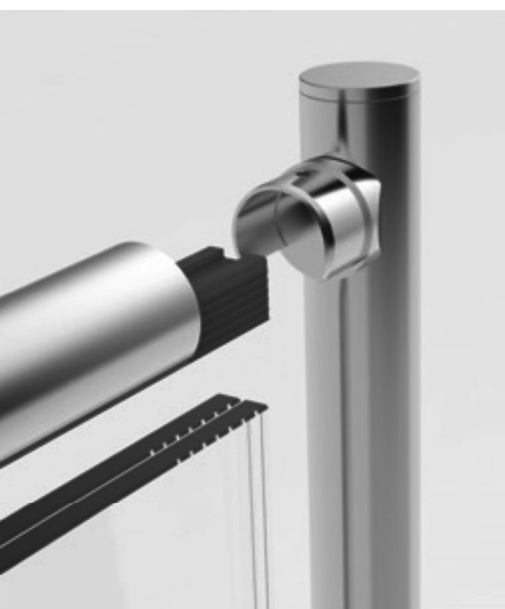

Fixação para tubo



para tubo de encaixe

Artigo N.º	Material	 para corrimão Ø
10213942A2	Aço inox AISI 304/Grão 240	1,5 42,4
10213942A4	Aço inox AISI 316/Grão 240	1,5 42,4

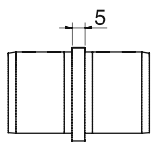

Uniões de tubos

para tubo de encaixe (180° horizontal)

Artigo N.º	Material	→✚←	para corrimão Ø
10214042A2	Aço inox AISI 304/Grão 240	1,5	42,4
10214042A4	Aço inox AISI 316/Grão 240	1,5	42,4

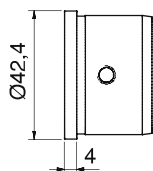
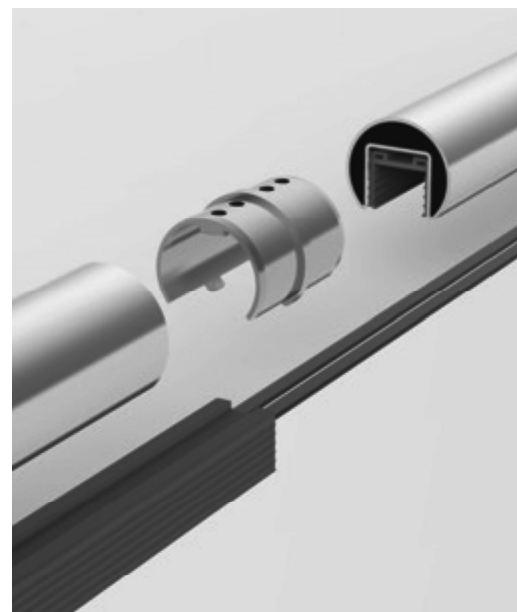

Tampa para topo

para tubo de encaixe

Artigo N.º	Material	→✚←	para corrimão Ø
10214142A2	Aço inox AISI 304/Grão 240	1,5	42,4
10214142A4	Aço inox AISI 316/Grão 240	1,5	42,4

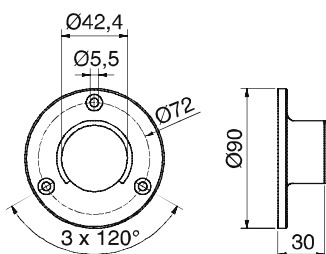

Fixação de parede

para tubo de encaixe

Artigo N.º	Material	→✚←	para corrimão Ø
10242742A2	Aço inox AISI 304/Grão 240	1,5	42,4
10242742A4	Aço inox AISI 316/Grão 240	1,5	42,4





Estudo de produto 2015
„Corrimão com iluminação” (em preparação)

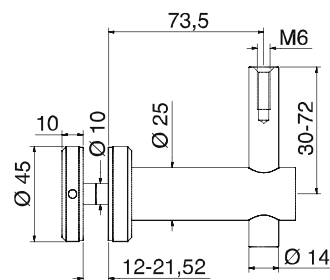

Suporte de corrimão



com fixação para vidro, ajustável em altura

Artigo N.º	Material	Furo no vidro	
10238044A2	Aço inox AISI 304/Grão 240	Ø 16	12 - 21,52

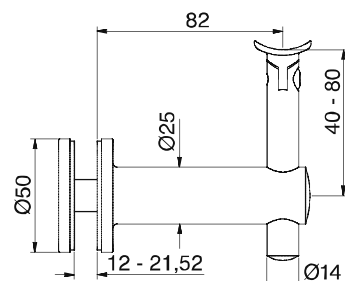

Suporte de corrimão articulado



com fixação para vidro, ajustável em altura

Artigo N.º	Material	Furo no vidro	
10241042A2	Aço inox AISI 304/Grão 240	Ø 16	12 - 21,52



Expositor cp-1402



Artigo N.º			Medidas
C54-1-PS	17,52	5,5	400 x 200 x 60 mm



Expositor cp-1400





Artigo N.º			Medidas
C57-1-PS	17,52	5,0	310x130x200 mm



Expositor cp-1404



Artigo N.º			Medidas
C58-1-PS	17,52	4,0	330x75x200 mm



DM--1402

